

JVC



ENGLISH

DEUTSCH

FRANÇAIS

NEDERLANDS

CASSETTE RECEIVER
CASSETTEN-RECEIVER
RADIOCASSETTE
RADIO/CASSETTESPELER

KS-FX202

KS-F162



KS-FX202

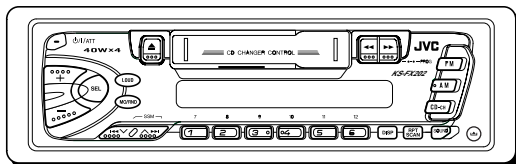

KS-F162

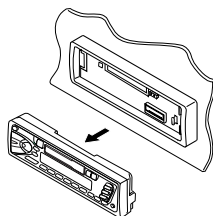
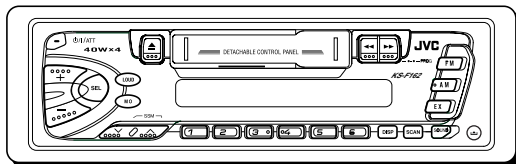

For installation and connections, refer to the separate manual.
Für den Einbau und die Anschlüsse siehe das eigenständige Handbuch.
Pour l'installation et les raccordements, se référer au manuel séparé.
Bijzonderheden over de installatie en aansluiting van het apparaat vindt u in de desbetreffende handleiding.

INSTRUCTIONS

BEDIENUNGSANLEITUNG
MANUEL D'INSTRUCTIONS
GEBRUIKSAANWIJZING

GET0055-001A
[E/EX]

Thank you for purchasing a JVC product. Please read all instructions carefully before operation, to ensure your complete understanding and to obtain the best possible performance from the unit.

CONTENTS

How to reset your unit	2	SOUND ADJUSTMENTS	12
LOCATION OF THE BUTTONS	3	Adjusting the sound	12
Control panel—KS-FX202	3	Turning on/off the loudness function	12
Control panel—KS-F162	4	Selecting preset sound modes	13
BASIC OPERATIONS	5	Storing your own sound adjustments	13
Turning on the power	5	OTHER MAIN FUNCTIONS	14
RADIO BASIC OPERATIONS	6	Setting the clock	14
Listening to the radio	6	Detaching the control panel	15
Storing stations in memory	8	CD CHANGER OPERATIONS	
Tuning into a preset station	8	(only for KS-FX202)	16
Scanning broadcast stations	9	Playing CDs	16
Storing your favorite station into the		Selecting CD playback modes	17
one-touch operation button (EX—extra)		MAINTENANCE	18
(only for KS-F162)	10	TROUBLESHOOTING	19
TAPE OPERATIONS	11	SPECIFICATIONS	21
Listening to a cassette	11		

How to reset your unit

Press and hold both the SEL (select) and ϕ /I/ATT (standby/on/attenuator) buttons at the same time for several seconds. This will reset the built-in microcomputer.

Note:

Your preset adjustments – such as preset channels or sound adjustments – will also be erased.

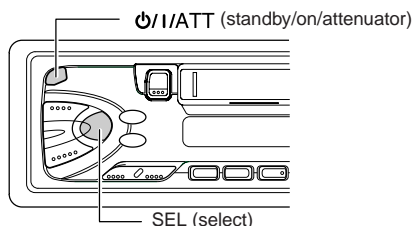

Note:

For security reasons, a numbered ID card is provided with this unit, and the same ID number is imprinted on the unit's chassis. Keep the card in a safe place, as it will help the authorities to identify your unit if stolen.

BEFORE USE

***For safety....**

- Do not raise the volume level too much, as this will block outside sounds, making driving dangerous.
- Stop the car before performing any complicated operations.

***Temperature inside the car....**

If you have parked the car for a long time in hot or cold weather, wait until the temperature in the car becomes normal before operating the unit.

LOCATION OF THE BUTTONS



Control panel—KS-FX202

ENGLISH

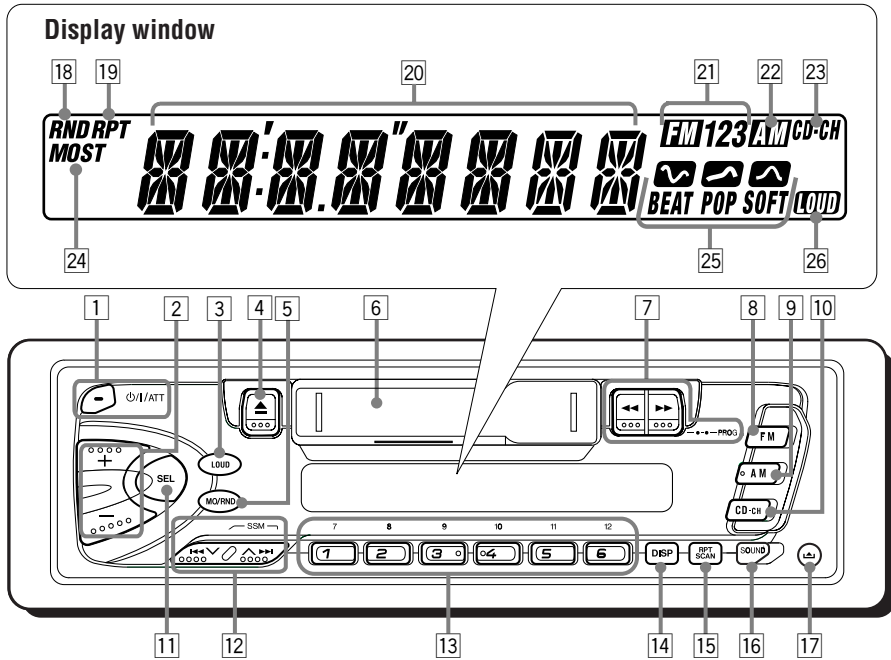

- 1 ϕ /I/ATT (standby/on/attenuator) button
- 2 +/– buttons
- 3 LOUD (loudness) button
- 4 \blacktriangle (eject) button
- 5 MO/RND (monaural/random) button
- 6 Cassette compartment
- 7 \blacktriangleleft / \blacktriangleright (PROG:program) buttons
- 8 FM button
- 9 AM button
- 10 CD-CH button
- 11 SEL (select) button
- 12 \blacktriangleleft ∇ / \blacktriangle \blacktriangleright buttons
 - Also functions as SSM buttons when pressed together.
- 13 Number buttons
- 14 DISP (display) button
- 15 RPT/SCAN (repeat/scan) button
- 16 SOUND button
- 17 \blacktriangle (control panel release) button

Display window

- 18 RND (random) indicator
- 19 RPT (repeat) indicator
- 20 Main display
- 21 FM band number indicators
FM1, FM2, FM3
- 22 AM indicator
- 23 CD-CH (CD changer) indicator
- 24 MO (monaural) indicator
ST (stereo) indicator
- 25 Sound mode indicators
BEAT, POP, SOFT
- 26 LOUD indicator



Control panel—KS-F162

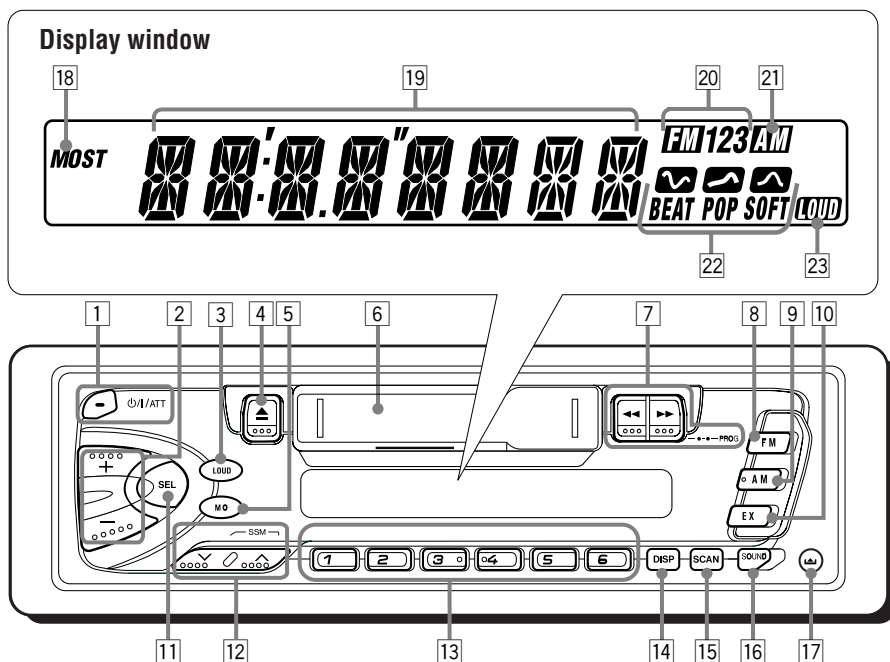

- 1 ϕ /I/ATT (standby/on/attenuator) button
- 2 +/- buttons
- 3 LOUD (loudness) button
- 4 \blacktriangle (eject) button
- 5 MO (monaural) button
- 6 Cassette compartment
- 7 $\blacktriangleleft\blacktriangleright$ (PROG:program) buttons
- 8 FM button
- 9 AM button
- 10 EX button
- 11 SEL (select) button
- 12 ∇/\blacktriangle buttons
 - Also functions as SSM buttons when pressed together.
- 13 Number buttons
- 14 DISP (display) button
- 15 SCAN button
- 16 SOUND button
- 17 \blacktriangle (control panel release) button

Display window

- 18 MO (monaural) indicator
- ST (stereo) indicator
- 19 Main display
- 20 FM band number indicators
FM1, FM2, FM3
- 21 AM indicator
- 22 Sound mode indicators
BEAT, POP, SOFT
- 23 LOUD indicator

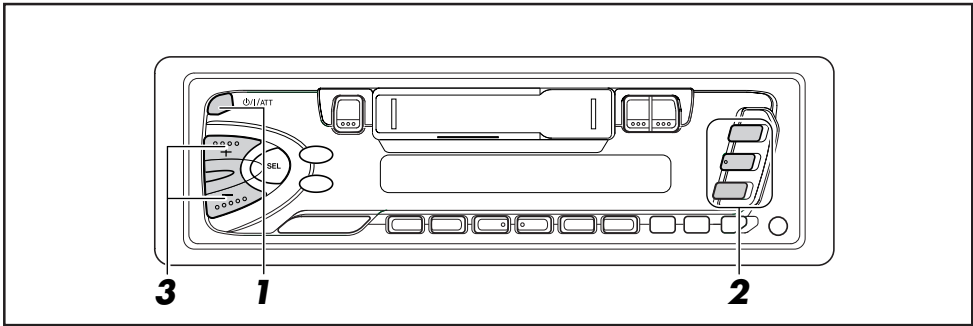

Turning on the power

1 Turn on the power.



Notes on One-Touch Operation:

- When you select a source in step 2 below, the power automatically comes on. You do not have to press this button to turn on the power.
- If the cassette is already in the cassette compartment, tape play starts automatically. However, it is not recommended to leave the cassette in the compartment when turning off the power or ignition key. It may damage the tape head and the cassette.

3 Adjust the volume.

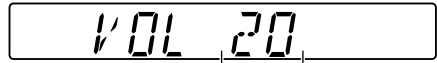
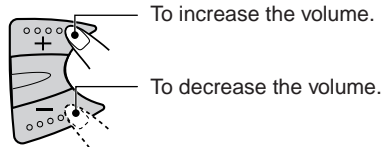

Volume level appears.

4 Adjust the sound as you want. (See pages 12 – 13.)

2 Select the source.

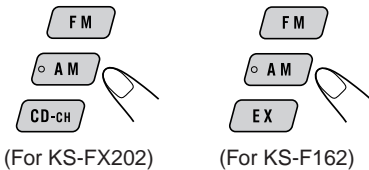

(For KS-FX202)

(For KS-F162)

To operate the tuner (FM or AM),
see pages 6 – 10.

To operate the tape,
see page 11.

To operate the CD changer
(only for KS-FX202),
see pages 16 – 17.

To operate the EX button
(only for KS-F162),
see page 10.

To drop the volume in a moment

Press **⏻/ATT** briefly while listening to any source. "ATT" starts flashing on the display, and the volume level will drop in a moment.

To resume the previous volume level, press the button briefly again.

To turn off the power

Press and hold **⏻/ATT** for more than 1 second.

Note:

When you use this unit for the first time, set the built-in clock correctly, see page 14.



RADIO BASIC OPERATIONS

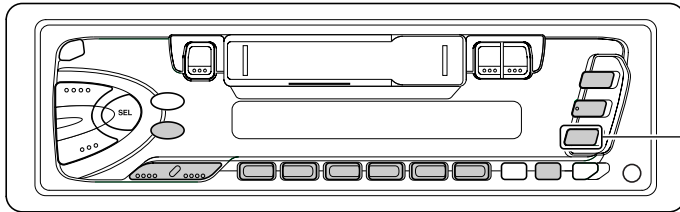

Only for KS-F162

Listening to the radio

You can use either automatic searching or manual searching to tune into a particular station.

Note:

When a cassette is in the cassette compartment, you cannot select the tuner. Be sure to eject the cassette from the cassette compartment to listen to the radio.

Searching a station automatically:

Auto search

1 Select the band (FM1 – 3, AM).

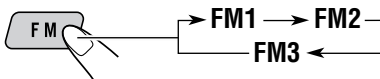

Selected band appears.

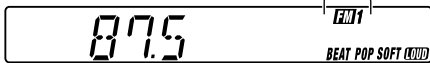

Note:

This receiver has three FM bands (FM1, FM2, FM3). You can use any one of them to listen to an FM broadcast.

2 Start searching a station.

To search stations of lower frequencies.

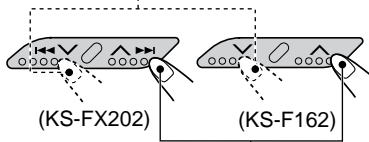

To search stations of higher frequencies.

When a station is received, searching stops.

To stop searching before a station is received, press the same button you have pressed for searching.

Searching a station manually:

Manual search

1 Select the band (FM1 – 3, AM).

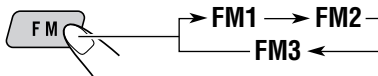

Note:

This receiver has three FM bands (FM1, FM2, FM3). You can use any one of them to listen to an FM broadcast.

2 Press and hold **|◀◀ ▼/▲ ▶▶|** (for KS-FX202) or **▼/▲** (for KS-F162) until **"M (manual)"** starts flashing on the display.

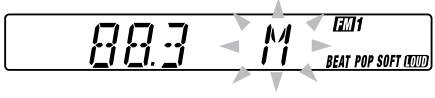

3 Tune into a station you want while **"M"** is flashing.

To tune into stations of lower frequencies.

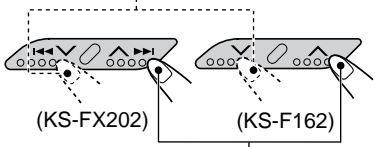

To tune into stations of higher frequencies.

- If you release your finger from the button, the manual mode will automatically turn off after 5 seconds.
- If you hold down the button, the frequency keeps changing (in 50 kHz intervals for FM and 9 kHz intervals for AM – MW/LW) until you release the button.

When an FM stereo broadcast is hard to receive:

Press **MO/RND** (for KS-FX202) or **MO** (for KS-F162) while listening to an FM stereo broadcast.

- Each time you press the button, the **MO** indicator lights up and goes off alternately.

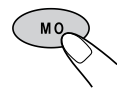

Lights up when receiving an FM broadcast in stereo.

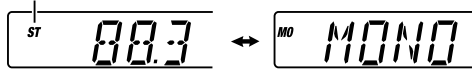

When the **MO** indicator is lit on the display, the sound you hear becomes monaural but the reception will be improved (the **ST** indicator goes off).

To restore the stereo effect, press the same button again.



Storing stations in memory

You can use one of the following two methods to store broadcasting stations in memory.

- Automatic preset of FM stations: SSM (Strong-station Sequential Memory)
- Manual preset of both FM and AM stations

FM station automatic preset: SSM

You can preset 6 local FM stations in each FM band (FM1, FM2, and FM3).

1 Select the FM band (FM1 – 3) you want to store FM stations into.



Each time you press the button, the FM band changes as follows:



2 Press and hold both buttons for more than 2 seconds.

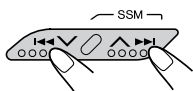

(For KS-FX202)

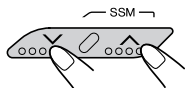

(For KS-F162)

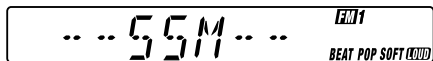

"SSM" appears, then disappears when automatic preset is over.

Local FM stations with the strongest signals are searched and stored automatically in the band number you have selected (FM1, FM2 or FM3). These stations are preset in the number buttons — No. 1 (lowest frequency) to No.6 (highest frequency). When automatic preset is over, the station stored in number button 1 will be automatically tuned into.

Manual preset

You can preset up to 6 stations in each band (FM1, FM2, FM3 and AM) manually.

Ex.: Storing an FM station of 88.3 MHz into the preset number 1 of the FM1 band

1 Select the band (FM1 – 3, AM) you want to store stations into (in this example, FM1).



Each time you press the button, the FM band changes as follows:



2 Tune into a station (in this example, of 88.3 MHz).

To tune into stations of lower frequencies.

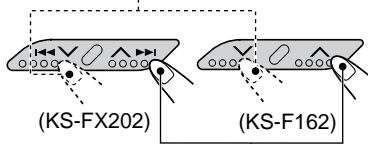

To tune into stations of higher frequencies.



3 Press and hold the number button (in this example, 1) for more than 2 seconds.



"P1" flashes for a few seconds.

4 Repeat the above procedure to store other stations into other preset numbers.

Notes:

- A previously preset station is erased when a new station is stored in the same preset number.
- Preset stations are erased when the power supply to the memory circuit is interrupted (for example, during battery replacement). If this occurs, preset the stations again.

Tuning into a preset station

You can easily tune into a preset station. Remember that you must store stations first. If you have not stored them yet, see "Storing stations in memory" on page 8.

1 Select the band (FM1 – 3, AM).

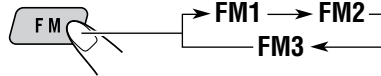

2 Select the number (1 – 6) for the preset station you want.

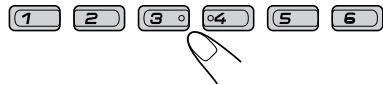

Scanning broadcast stations



(For KS-FX202)



(For KS-F162)

When you press RPT/SCAN (for KS-FX202) or SCAN (for KS-F162) while listening to the radio, station scanning start. Each time a broadcast is tuned in, scanning stops for about 5 seconds (tuned frequency number flashes on the display), and you can check what program is now being broadcast.

If you want to listen to that program, press the same button again to stop scanning.



Storing your favorite station into the one-touch operation button (EX—extra)

This section is only for KS-F162.

You can preset an FM or AM station (such as your favorite station or traffic announcement station); and recall it by one touch operation even if the unit is turned off.

Ex.: Storing an FM station of 88.3 MHz into the one-touch operation button (EX).

1 Select the band (FM1 – 3, AM) you want to store stations into (in this example, FM1).



Each time you press the button, the FM band changes as follows:



2 Tune into a station (in this example, of 88.3 MHz).

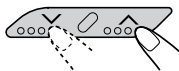

3 Press and hold the button for more than 2 seconds.

"P0" flashes on the display, showing that the station has been preset.



Notes:

- A previously preset station is erased when a new station is stored in the EX button.
- The preset station is erased when the power supply to the memory circuit is interrupted (for example, during battery replacement). If this occurs, preset the station again.

To tune in the favorite station



The unit automatically turns on (if it has been off).

Your favorite station is tuned in—except when the tape is playing.

- If you press the button again, the last received station will be tuned in.

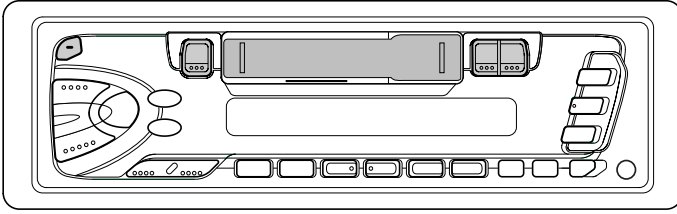

Listening to a cassette

You can play back type 1 (normal) tapes.

1 Turn on the power.



Note on One-Touch Operation:

If a cassette is already in the cassette compartment, tape play starts automatically. However, it is not recommended to leave the cassette in the compartment when turning off the power or ignition key. It may damage the tape head and the cassette.

2 Insert a cassette into the cassette compartment.

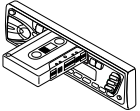

When one side of the tape reaches its end during play, the other side of the tape automatically starts playing (Auto Reverse).

3 Select the tape direction.

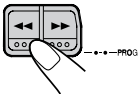

Press both buttons at the same time. Each time you press both buttons, the tape direction changes alternately—forward (TAPE : : :) and reverse (TAPE : : :).

To stop play and eject the cassette

Press ▲.

Tape play stops and the cassette automatically ejects from the cassette compartment. The source changes to the previously selected one.

- You cannot change the source if the cassette is still in the cassette compartment. To change the source, you must eject the cassette first.
- You can also eject the cassette by pressing ▲ while the unit is turned off.

To fast-wind a tape

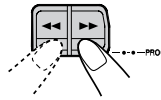

Press in ►► or ◀◀.

The tape will be wound in the direction of the arrows (►► or ◀◀).

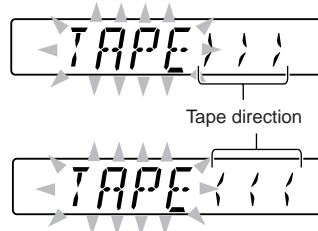

To restart playback, lightly press the other button which is not pressed in (◀◀ or ►►).



SOUND ADJUSTMENTS

ENGLISH

Adjusting the sound

You can adjust the sound characteristics to your preference.

1 Select the item you want to adjust.



Each time you press the button, the adjustable items change as follows:

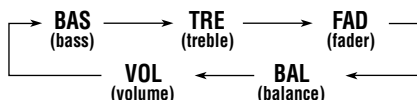

Indication	To do:	Range
BAS	Adjust the bass.	-6 (min.) +6 (max.)
TRE	Adjust the treble.	-6 (min.) +6 (max.)
FAD*	Adjust the front and rear speaker balance.	R6 (Rear only) F6 (Front only)
BAL	Adjust the left and right speaker balance.	L6 (Left only) R6 (Right only)
VOL	Adjust the volume.	00 (min.) 50 (max.)

* If you are using a two-speaker system, set the fader level to "00."

2 Adjust the level.

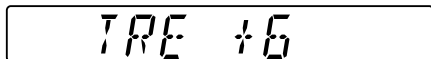
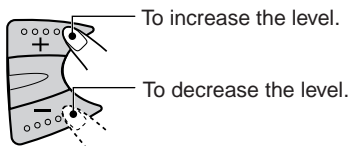

Note:

Normally, the + and - buttons work as the volume control. So you do not have to select "VOL" to adjust the volume level.

Turning on/off the loudness function

The human ear is less sensitive to low and high frequencies at low volumes.

The loudness function can boost these frequencies to produce a well-balanced sound at low volume levels.

Each time you press LOUD, the loudness function turns on and off alternately.

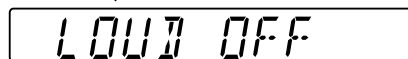
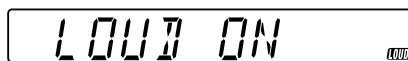



Selecting preset sound modes

You can select a preset sound adjustment suitable to the music genre.

Select the sound mode you want.



Each time you press the button, the sound mode changes as follows:



Indication	For:	Preset values		
		BAS	TRE	LOUD
SCM OFF	(Flat sound)	00	00	ON
BEAT	Rock or disco music	+2	00	ON
POP	Light music	+4	+1	OFF
SOFT	Quiet background music	+1	-3	OFF

Notes:

- You can adjust each sound mode to your preference, and store it in memory.
If you want to adjust and store your original sound mode, see "Storing your own sound adjustments" below.
- To adjust the bass and treble reinforcement levels or to turn on/off the loudness function temporarily, see the right column. (Your adjustments will be canceled if another source is selected.)

Storing your own sound adjustments

You can adjust the sound modes (BEAT, POP, SOFT) to your preference and store your own adjustments in memory.

- There is a time limit in doing the following procedure. If the setting is canceled before you finish, start from step 1 again.

1 Call up the sound mode you want to adjust.



- See the left column for details.

2 To adjust the bass or treble sound level.



Select "BAS" or "TRE."

To turn on or off the loudness function.



Each time you press LOUD, the loudness function turns on and off alternately.

→ go to step 4.

3 Adjust the bass or treble level.

- See page 12 for details.

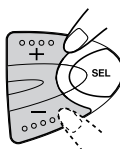

4 Press and hold SOUND until the sound mode you have selected in step 1 flashes on the display.



Your adjustment made for the selected sound mode is stored in memory.

5 Repeat the same procedure to store other sound modes.

To reset to the factory settings

Repeat the same procedure and reassign the preset values listed in the table on the left column.

Setting the clock

- 1** Press and hold SEL (select) for more than 2 seconds.
 "CLOCK H" or "CLOCK M" appears on the display.



2 Set the hour.

- 1** Select "CLOCK H (hour)" if not shown on the display.



- 2** Adjust the hour.

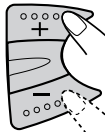

3 Set the minute.

- 1** Select "CLOCK M (minute)."



- 2** Adjust the minute.

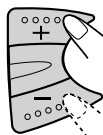

- 4** Press SEL (select) to finish the setting.



To check the current clock time or change the display mode



Press DISP repeatedly. Each time you press the button, the display mode changes as follows:

- During tuner operation:
Frequency ↔ **Clock**
- During tape operation:
Play mode (tape direction) ↔ **Clock**
- During CD changer operation:
 (only for KS-FX202)
Disc number → **Clock** → **Elapsed playing time**

Detaching the control panel

You can detach the control panel when leaving the car.
When detaching or attaching the control panel, be careful not to damage the connectors on the back of the control panel and on the panel holder.

Detaching the control panel

Before detaching the control panel, be sure to turn off the power.

- 1 Unlock the control panel.

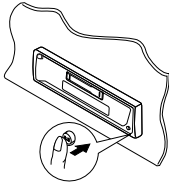

- 2 Lift and pull the control panel out of the unit.

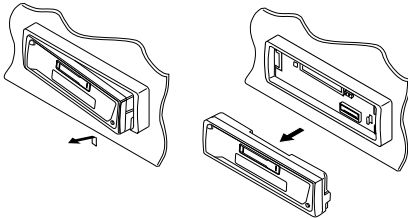

- 3 Put the detached control panel into the provided case.

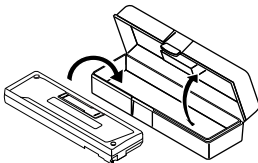

Attaching the control panel

- 1 Insert the left side of the control panel into the groove on the panel holder.

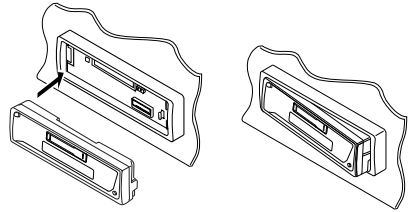

- 2 Press the right side of the control panel to fix it to the panel holder.

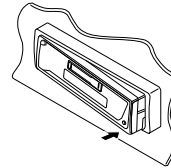

Note on cleaning the connectors:

If you frequently detach the control panel, the connectors will deteriorate.

To minimize this possibility, periodically wipe the connectors with a cotton swab or cloth moistened with alcohol, being careful not to damage the connectors.

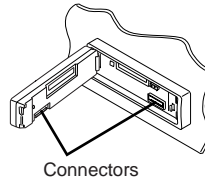



CD CHANGER OPERATIONS

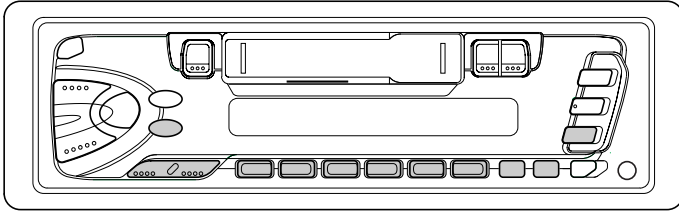

This section is only for KS-FX202.

We recommend that you use one of the CH-X series with your unit.

If you have another CD automatic changer, consult your JVC IN-CAR ENTERTAINMENT dealer for connections.

- For example, if your CD automatic changer is one of the KD-MK series, you need a cord (KS-U15K) for connecting it to this unit.

Before operating your CD automatic changer:

- Refer also to the Instructions supplied with your CD changer.
- If no discs are in the magazine of the CD changer or the discs are inserted upside down, "NO CD" or "NO DISC" will appear on the display. If this happens, remove the magazine and set the discs correctly.
- If "RESET 1" – "RESET 8" appears on the display, something is wrong with the connection between this unit and the CD changer. If this happens, check the connection and make sure the cords are connected firmly. Then, press the reset button of the CD changer.

Playing CDs

Select the CD automatic changer (CD-CH).



Playback starts from the first track of the first disc.
All tracks of all discs are played back.

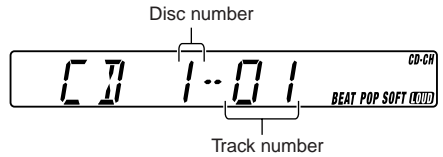

Note on One-Touch Operation:

When you press CD-CH, the power automatically turns on. You do not have to press /ATT to turn on the power.

To check the elapsed playing time.

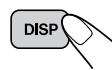

Press DISP (display) repeatedly.
Each time you press the button, the display mode changes as follows:

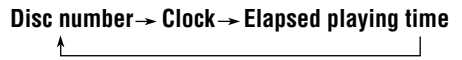

To fast-forward or reverse the track

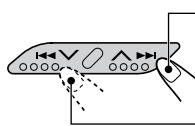

Press and hold , while playing a CD, to fast-forward the track.

Press and hold , while playing a CD, to reverse the track.

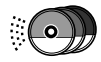

To go to the next track or the previous tracks

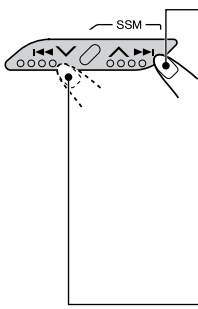

Press **▲▶▶** briefly, while playing a CD, to go ahead to the beginning of the next track. Each time you press the button consecutively, the beginning of the next track is located and played back.

Press **◀◀▼** briefly, while playing a CD, to go back to the beginning of the current track. Each time you press the button consecutively, the beginning of the previous tracks is located and played back.

To go to a particular disc directly

Press the number button corresponding to the disc number to start its playback (while the CD changer is playing).

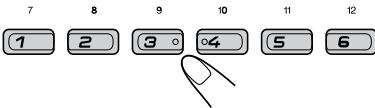

- To select a disc number from 1 – 6:
Press 1 (7) – 6 (12) briefly.
- To select a disc number from 7 – 12:
Press and hold 1 (7) – 6 (12) for more than 1 second.

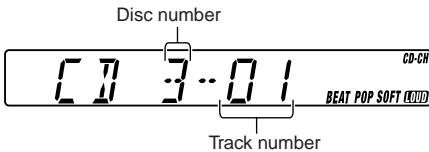

Ex.: When disc number 3 is selected.

Selecting CD playback modes

To play back tracks at random (Random Play)



Each time you press the button, CD random play mode changes as follows:



Mode	RND Indicator	Plays at random
RND1 (random1)	Lights	All tracks of the current disc, then the tracks of the next disc, and so on.
RND2 (random2)	Flashes	All tracks of all discs inserted in the magazine.

To play back tracks repeatedly (Repeat Play)



Each time you press the button, CD repeat play mode changes as follows:



Mode	RPT Indicator	Plays repeatedly
RPT1 (repeat1)	Lights	The current track (or specified track).
RPT2 (repeat2)	Flashes	All tracks of the current disc (or specified disc).



MAINTENANCE

This unit requires very little attention, but you will be able to extend the life of the unit if you follow the instructions below.

To clean the head

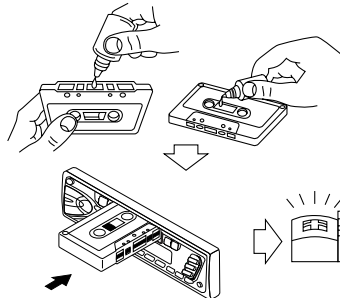

- Clean the head after every 10 hours of use using a wet-type head cleaning tape (available at an audio store).
When the head becomes dirty, you may realize the following symptoms:
 - Sound quality is reduced.
 - Sound level decreases.
 - Sound drops out.
- Do not play dirty or dusty tapes.
- Do not touch the highly-polished head with any metallic or magnetic tools.

To keep the tape clean

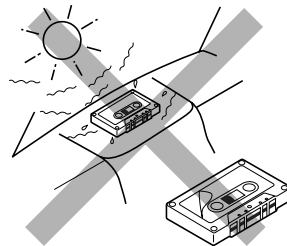

- Always store the cassettes to their storage cases after use.
- Do not store cassettes in the following places:
 - Subject to direct sunlight
 - With high humidity
 - At extremely hot temperatures

CAUTION:

- *Do not play the cassettes with peeling labels; otherwise, they can damage the unit.*
- *Tighten tapes to remove slack since loose tape may become entangled with the mechanism.*
- *Do not leave a cassette in the cassette compartment after use, as the tape may become slack.*

TROUBLESHOOTING



What appears to be trouble is not always serious. Check the following points before calling a service center.

Symptoms	Causes	Remedies
<ul style="list-style-type: none"> A cassette tape cannot be inserted. 	You have tried to insert a cassette in the wrong way.	Insert the cassette with the exposed tape facing right.
<ul style="list-style-type: none"> Cassette tapes become hot. 	This is not a malfunction.	_____
<ul style="list-style-type: none"> Tape sound is at very low level and sound quality is degraded. 	The tape head is dirty.	Clean it with a head cleaning tape.
<ul style="list-style-type: none"> Sound is sometimes interrupted. 	Connections are not good.	Check the cords and connections.
<ul style="list-style-type: none"> Sound cannot be heard from the speakers. 	The volume is turned to the minimum level.	Adjust it to the optimum level.
	Connections are incorrect.	Check the cords and connections.
<ul style="list-style-type: none"> SSM (Strong-station Sequential Memory) automatic preset does not work. 	Signals are too weak.	Store stations manually.
<ul style="list-style-type: none"> Static noise while listening to the radio. 	The antenna is not connected firmly.	Connect the antenna firmly.
<ul style="list-style-type: none"> This unit does not work at all. 	The built-in microcomputer may function incorrectly due to noise, etc.	Press and hold both the SEL (select) and /ATT buttons at the same time for several seconds. (The clock setting and preset stations stored in memory are erased.) (See page 2.)

**Only for KS-FX202**

Symptoms	Causes	Remedies
• “NO CD” or “NO DISC” appears on the display.	No CD is in the magazine.	Insert CDs into the magazine.
	CDs are inserted incorrectly.	Insert them correctly.
• “NO MAG” appears on the display.	No magazine is loaded in the CD changer.	Insert the magazine.
• “RESET 8” appears on the display.	This unit is not connected to a CD changer correctly.	Connect this unit and the CD changer correctly and press the reset button of the CD changer.
• “RESET 1” – “RESET 7” appears on the display.	_____	Press the reset button of the CD changer.
• The CD changer does not work at all.	The built-in microcomputer may function incorrectly due to noise, etc.	Press and hold both the SEL (select) and /I/ATT buttons at the same time for several seconds. (The clock setting and preset stations stored in memory are erased.) (See page 2.)

AUDIO AMPLIFIER SECTION

Maximum Power Output:

Front: 40 W per channel

Rear: 40 W per channel

Continuous Power Output (RMS):

Front: 16 W per channel into 4 Ω , 40 Hz to 20 000 Hz at no more than 0.8% total harmonic distortion.

Rear: 16 W per channel into 4 Ω , 40 Hz to 20 000 Hz at no more than 0.8% total harmonic distortion.

Load Impedance: 4 Ω (4 Ω to 8 Ω allowance)

Tone Control Range:

Bass: ± 10 dB at 100 Hz

Treble: ± 10 dB at 10 kHz

Frequency Response: 40 Hz to 20 000 Hz

Signal-to-Noise Ratio: 70 dB

Line-Out Level/Impedance:

KS-FX202: 2.0 V/20 k Ω load (250 nWb/m)

KS-F162: 1.0 V/20 k Ω load (250 nWb/m)

CASSETTE DECK SECTION

Wow & Flutter: 0.15% (WRMS)

Fast-Wind Time: 190 sec. (C-60)

Frequency Response: 50 Hz to 14 000 Hz
(Normal tape)

Signal-to-Noise Ratio: 52 dB

Stereo Separation: 40 dB

GENERAL

Power Requirement:

Operating Voltage: DC 14.4 V

(11 V to 16 V allowance)

Grounding System: Negative ground

Allowable Operating Temperature: 0°C to +40°C

Dimensions (W \times H \times D):

Installation Size: 182 mm \times 52 mm \times 150 mm

Panel Size: 188 mm \times 58 mm \times 14 mm

Mass: 1.3 kg (excluding accessories)

TUNER SECTION

Frequency Range:

FM: 87.5 MHz to 108.0 MHz

AM: (MW) 522 kHz to 1 620 kHz

(LW) 144 kHz to 279 kHz

Design and specifications subject to change without notice.

[FM Tuner]

Usable Sensitivity: 11.3 dBf (1.0 μ V/75 Ω)

50 dB Quieting Sensitivity:

16.3 dBf (1.8 μ V/75 Ω)

Alternate Channel Selectivity (400 kHz):

65 dB

Frequency Response: 40 Hz to 15 000 Hz

Stereo Separation: 30 dB

Capture Ratio: 2.0 dB

[MW Tuner]

Sensitivity: 20 μ V

Selectivity: 35 dB

[LW Tuner]

Sensitivity: 50 μ V



Having TROUBLE with operation?

Please reset your unit

Refer to page of How to reset your unit

Haben Sie PROBLEME mit dem Betrieb?

Bitte setzen Sie Ihr Gerät zurück

Siehe Seite Zurücksetzen des Geräts

Vous avez des PROBLÈMES de fonctionnement?

Réinitialisez votre appareil

Référez-vous à la page intitulée Comment réinitialiser votre appareil

Hebt u PROBLEMEN met de bediening?

Stel het apparaat terug

Zie de pagina met de paragraaf Het apparaat terugstellen

JVC

VICTOR COMPANY OF JAPAN, LIMITED

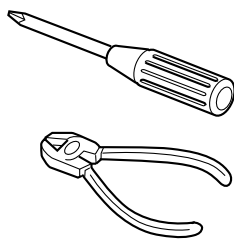

ENGLISH

DEUTSCH

FRANÇAIS

NEDERLANDS

- This unit is designed to operate on 12 V DC, NEGATIVE ground electrical systems.

- Dieses Gerät ist für einen Betrieb in elektrischen Anlagen mit 12 V Gleichstrom und (-) Erdung ausgelegt.

- Cet appareil est conçu pour fonctionner sur des sources de courant continu de 12 V à masse NEGATIVE.

- Dit apparaat mag worden gebruikt bij elektrische systemen die werken op 12 V gelijkstroom met negatieve aarding.

INSTALLATION (IN-DASH MOUNTING)

EINBAU (IM ARMATURENBRETT)

INSTALLATION (MONTAGE DANS LE TABLEAU DE BORD)

INSTALLATIE (INBOUW IN HET DASHBOARD)

- The following illustration shows a typical installation. However, you should make adjustments corresponding to your specific car. If you have any questions or require information regarding installation kits, consult your JVC IN-CAR ENTERTAINMENT dealer or a company supplying kits.

- Die folgende Abbildung zeigt einen typischen Einbau. Dennoch müssen Sie entsprechend Ihrem jeweiligen Auto Anpassungen vornehmen. Bei irgendwelchen Fragen oder wenn Sie Informationen hinsichtlich des Einbausatzes brauchen, wenden Sie sich an ihren JVC Autoradiohändler oder ein Unternehmen das diese Einbausätze vertreibt.

- L'illustration suivante est un exemple d'installation typique. Cependant, vous devez faire les ajustements correspondant à votre voiture particulière. Si vous avez des questions ou avez besoin d'information sur des kits d'installation, consulter votre revendeur d'autoradios JVC ou une compagnie d'approvisionnement.

- Op de volgende afbeelding kunt u zien hoe de installatie, normaal gesproken, in zijn werk gaat. U moet echter bij de installatie rekening houden met de bijzonderheden van uw eigen auto. Neem bij vragen of voor meer bijzonderheden over inbouwpakketten contact op met uw JVC car audio dealer of een dealer of een bedrijf dat inbouwpakketten levert.

- 1 Before mounting:** Press (Control Panel Release button) to detach the control panel.

- 1 Vor dem Einbau:** Drücken Sie (Freigabe der Schalttafel), um die Arretierung der Schalttafel zu lösen.

- 1 Avant le montage:** Appuyer sur (déblocage du panneau de commande) pour détacher le panneau de commande.

- 1 Voordat u aan de montage van het apparaat begint:** Druk op (het bedieningspaneel vrijgeven) als u het bedieningspaneel wilt loskoppelen.

- 2 Remove the trim plate.**
- 3 Remove the sleeve after disengaging the sleeve locks.**

- 2 Den Frontrahmen herausnehmen.**
- 3 Die Halterung nach dem Entriegeln der Halterungssperren abnehmen.**

- 2 Retirer la plaque d'assemblage.**
- 3 Libérer les verrous du manchon et retirer le manchon.**

- 2 Verwijder de sierplaat.**
- 3 Verwijder het huis nadat u de klemmen hebt losgemaakt.**

- 1 Stand the unit.**
Note: When you stand the unit, be careful not to damage the fuse on the rear.
- 2 Insert the 2 handles between the unit and the sleeve, as illustrated, to disengage the sleeve locks.**
- 3 Remove the sleeve.**
Note: Be sure to keep the handles for future use after installing the unit.

- 1 Das Gerät aufstellen.**
Hinweis: Beim Aufstellen des Geräts darauf achten, daß die Sicherung auf der Rückseite nicht beschädigt wird.
- 2 Die 2 Griffe zwischen dem Gerät und der Halterung wie abgebildet einstecken und die Halterungssperren entriegeln.**
- 3 Die Halterung entfernen.**
Hinweis: Sicherstellen, daß die Griffe für künftigen Gebrauch nach dem Einbau des Geräts aufbewahrt werden.

- 1 Poser l'appareil à la verticale.**
Remarque: Lorsque vous mettez l'appareil à la verticale, faire attention de ne pas endommager le fusible situé sur l'arrière.
- 2 Insérer les 2 poignées entre l'appareil et le manchon comme indiqué pour désengager les verrous de manchon.**
- 3 Retirer le manchon.**
Remarque: S'assurer de garder les poignées pour une utilisation ultérieure, après l'installation de l'appareil.

- 1 Zet het apparaat rechtop.**
Opmerking: Wanneer u het apparaat rechtop zet, moet u erop letten dat u de zekering aan de achterkant niet beschadigt.
- 2 Plaats de 2 hendels, zoals afgebeeld, tussen het apparaat en het huis, om de klemmen los te maken.**
- 3 Verwijder het huis.**
Opmerking: Bewaar de hendels nadat u het apparaat hebt geïnstalleerd, zodat u ze ook in de toekomst kunt gebruiken.

- 4 Install the sleeve into the dashboard.**
* After the sleeve is correctly installed into the dashboard, bend the appropriate tabs to hold the sleeve firmly in place, as illustrated.
- 5 Fix the mounting bolt to the rear of the unit's body and place the rubber cushion over the end of the bolt.**
- 6 Do the required electrical connections.**
- 7 Slide the unit into the sleeve until it is locked.**
- 8 Attach the trim plate so that the projection on the trim plate is fixed to the left side of the unit.**
- 9 Attach the control panel.**

- 4 Die Halterung im Armaturenbrett einbauen.**
* Nach dem korrekten Einbau der Halterung im Armaturenbrett, die entsprechenden Riegel umknicken, um die Halterung an ihrem Platz zu sichern, siehe Abbildung.
- 5 Die Befestigungsschraube an der Rückseite des Gerätekörpers befestigen und das Ende der Schraube mit einem Gummipuffer abdecken.**
- 6 Nehmen Sie die erforderlichen elektrischen Anschlüsse vor.**
- 7 Das Gerät in die Halterung schieben, bis es einrastet.**
- 8 Befestigen Sie die Frontrahmen in der Form, daß der Fortsatz der Frontrahmen auf der linken Seite des Geräts befestigt wird.**
- 9 Die Schalttafel anbringen.**

- 4 Installer le manchon dans le tableau de bord.**
* Après installation correcte du manchon dans le tableau de bord, plier les bonnes pattes pour maintenir fermement le manchon en place, comme montré.
- 5 Monter le boulon de montage sur l'arrière du corps de l'appareil puis passer l'amortisseur en caoutchouc sur l'extrémité du boulon.**
- 6 Réalisez les connexions électriques.**
- 7 Faire glisser l'appareil dans le manchon jusqu'à ce qu'il soit verrouillé.**
- 8 Attachez la plaque d'assemblage de façon que la projection de la plaque d'assemblage soit fixée sur le côté gauche de l'appareil.**
- 9 Remonter le panneau de commande.**

- 4 Installeer het huis in het dashboard.**
* Nadat het huis op de juiste wijze in het dashboard is geplaatst, moet u de palletjes, zoals afgebeeld, stevig op hun plaats duwen.
- 5 Maak de bevestigingsbout aan de achterkant van het apparaat vast en plaats de rubberdop over het uiteinde van de bout.**
- 6 Breng de vereiste elektrische verbindingen tot stand.**
- 7 Schuif het apparaat in het huis totdat het vergrendeld is.**
- 8 Bevestig de sierplaat zodanig dat het uitstekende deel van de plaat aan de linkerkant van de eenheid vast komt te zitten.**
- 9 Bevestig het bedieningspaneel.**

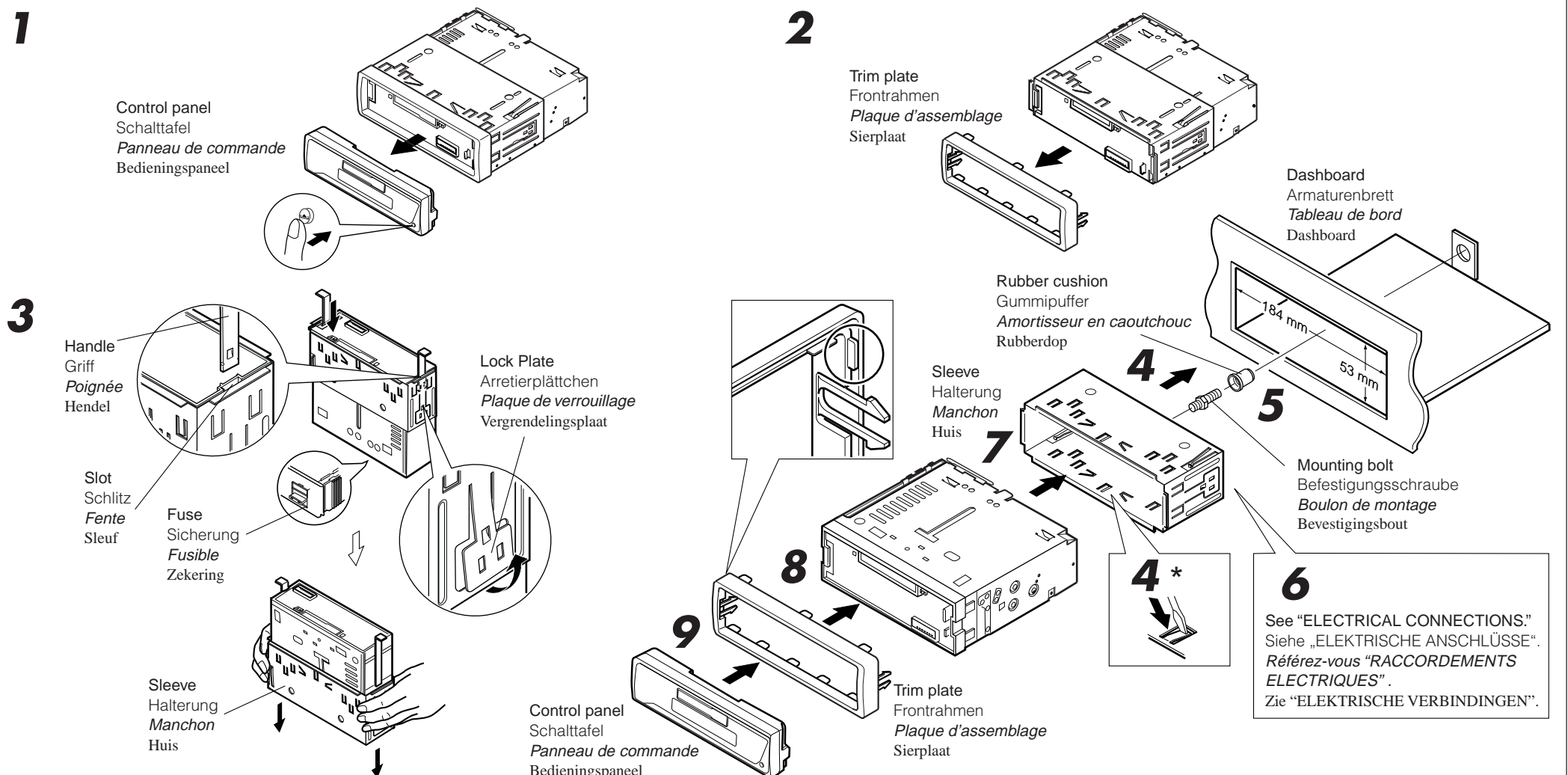

- When using the optional stay
- Beim Verwenden der Anker-Option
- Lors de l'utilisation du hauban en option
- Wanneer u de steun gebruikt (facultatief)

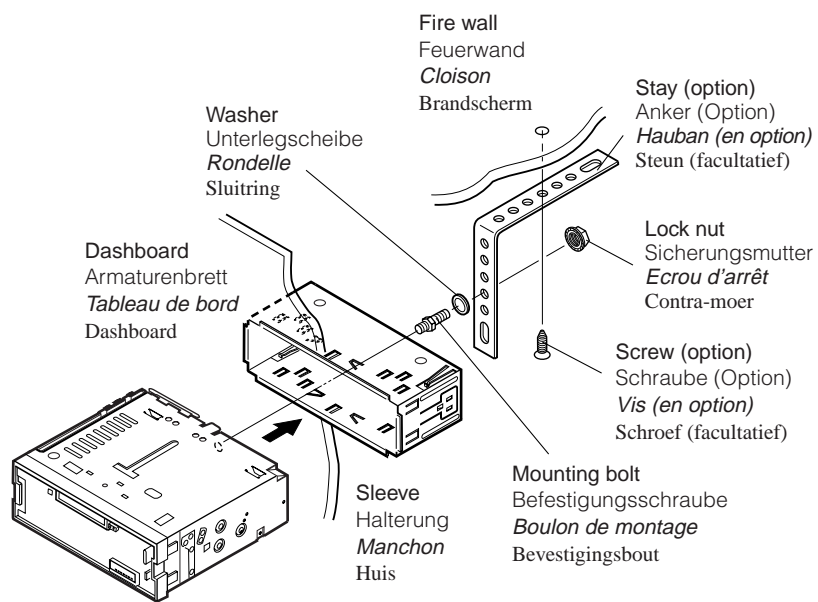

- When installing the unit without using the sleeve
- Beim Einbau des Geräts ohne Halterung
- Lors de l'installation de l'appareil sans utiliser de manchon
- Wanneer u het apparaat zonder huis installeert

In a Toyota for example, first remove the car radio and install the unit in its place.
Zum Beispiel in einem Toyota zuerst das Autoradio ausbauen und dann das Gerät an seinem Platz einbauen.
Par exemple dans une Toyota, retirer d'abord l'autoradio et installer l'appareil à la place.
Voorbeeld: Bij een Toyota moet u eerst de autoradio verwijderen en daarna het apparaat installeren.

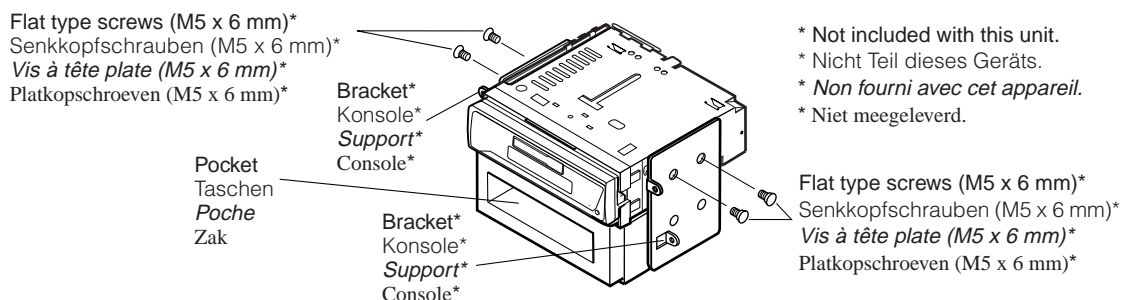

Note: When installing the unit on the mounting bracket, make sure to use the 6 mm-long screws. If longer screws are used, they could damage the unit.

Hinweis: Beim Anbringen des Gerät an der Konsole sicherstellen, daß 6 mm lange Schrauben verwendet werden. Werden längere Schrauben verwendet, können sie das Gerät beschädigen.

Remarque: Lors de l'installation de l'appareil sur le support de montage, s'assurer d'utiliser des vis d'une longueur de 6 mm. Si des vis plus longues sont utilisées, elles peuvent endommager l'appareil.

Opmerking: Wanneer u het apparaat aan de bevestigingsklem vastmaakt, moet u de 6 mm lange schroeven gebruiken. Als u langere schroeven gebruikt, kan het apparaat worden beschadigd.

Removing the unit

• Before removing the unit, release the rear section.

- 1 Remove the control panel.
- 2 Remove the trim plate.
- 3 Insert the 2 handles into the slots, as shown. Then, while gently pulling the handles away from each other, slide out the unit. **(Be sure to keep the handles after installing it.)**

Ausbau des Geräts

• Vor dem Ausbau des Geräts den hinteren Teil freigeben.

- 1 Den Schalttafel abnehmen.
- 2 Den Frontrahmen herausnehmen.
- 3 Die 2 Griffe in die Schlitzte wie gezeigt stecken. Dann die Griffe behutsam auseinander ziehen und das Gerät herausziehen. **(Die Griffe nach dem Einbau auf jeden Fall aufbewahren.)**

Retrait de l'appareil

• Avant de retirer l'appareil, libérer la section arrière.

- 1 Retirer le panneau de commande.
- 2 Retirer la plaque d'assemblage.
- 3 Introduire les 2 poignées dans les fentes, comme montré. Puis, tout en tirant doucement les poignées écartées, faire glisser l'appareil pour le sortir. **(S'assurer de conserver les poignées après l'installation de l'appareil.)**

Verwijderen van het apparaat

• Voordat u het apparaat verwijdert, moet u het achtergedeelte losmaken.

- 1 Verwijder het bedieningspaneel.
- 2 Verwijder de sierplaat.
- 3 Plaats de 2 hendels, zoals afgebeeld, in de sleuven. Daarna duwt u de hendels zachtjes uit elkaar en kunt u het apparaat naar buiten schuiven. **(Bewaar de hendels nadat u het apparaat hebt geïnstalleerd!)**

1

Control panel
Schalttafel
Panneau de commande
Bedieningspaneel

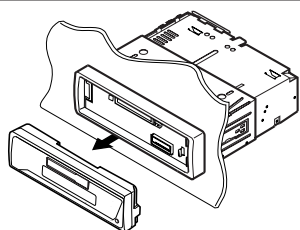

2

Trim plate
Frontrahmen
Plaque d'assemblage
Sierplaat

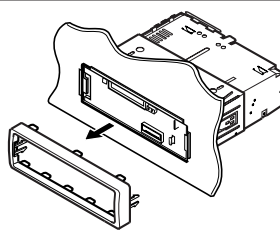

3

Handle
Griff
Poignée
Hendel

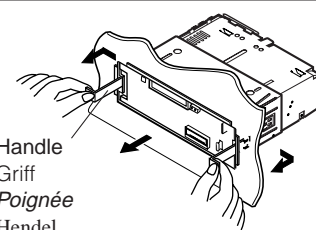

Parts list for installation and connection

The following parts are provided with this unit. After checking them, please set them correctly.

Teileliste für den Einbau und Anschluß

Die folgenden Teile werden zusammen mit diesem Gerät geliefert. Nach ihrer Überprüfung, die Teile richtig einsetzen.

Liste des pièces pour l'installation et raccordement

Les pièces suivantes sont fournies avec cet appareil. Après vérification, veuillez les placer correctement.

Lijst van onderdelen die u bij installatie en aansluiting nodig hebt

De volgende onderdelen worden bij het apparaat geleverd. Installeer ze op de juiste wijze, nadat u ze hebt gecontroleerd.

Hard case
Etui
Etui de transport
Behuizing

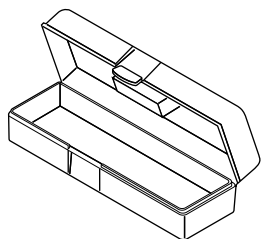

Sleeve
Halterung
Manchon
Huis

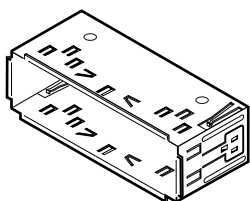

Trim plate
Frontrahmen
Plaque d'assemblage
Sierplaat

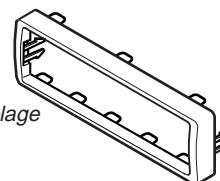

Power cord
Stromkabel
Cordon d'alimentation
Stroomkabel

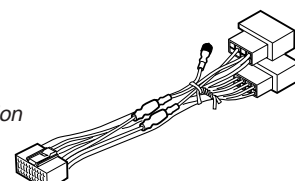

Handles
Griffe
Poignées
Hendels

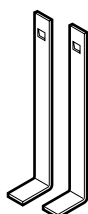

Washer (ø5)
Unterlegscheibe(ø5)
Rondelle (ø5)
Sluistring (ø5)



Lock nut (M5)
Sicherungsmutter (M5)
Ecrou d'arrêt (M5)
Contra-moer (M5)



Mounting bolt (M5 x 20 mm)
Befestigungsschraube (M5 x 20 mm)
Boulon de montage (M5 x 20 mm)
Bevestigingsbout (M5 x 20 mm)



Rubber cushion
Gummipuffer
Amortisseur en caoutchouc
Rubberdop



ELECTRICAL CONNECTIONS

ELEKTRISCHE ANSCHLÜSSE

RACCORDEMENTS ELECTRIQUES

ELEKTRISCHE VERBINDINGEN

To prevent short circuits, we recommend that you disconnect the battery's negative terminal and make all electrical connections before installing the unit. If you are not sure how to install this unit correctly, have it installed by a qualified technician.

Zur Vermeidung von Kurzschlüssen empfehlen wir, daß Sie den negativen Batterieanschluß abtrennen und alle elektrischen Anschlüsse herstellen, bevor das Gerät eingebaut wird. Sind Sie sich über den richtigen Einbau des Geräts nicht sicher, lassen Sie es von einem qualifizierten Techniker einbauen.

Pour éviter tout court-circuit, nous vous recommandons de débrancher la borne négative de la batterie et d'effectuer tous les raccordements électriques avant d'installer l'appareil. Si l'on n'est pas sûr de pouvoir installer correctement cet appareil, le faire installer par un technicien qualifié.

Om kortsluiting te voorkomen adviseren wij u om de minpool van de accu los te maken en alle elektrische verbindingen tot stand te brengen voordat u het apparaat in de auto installeert. Als u niet zeker weet hoe u dit apparaat moet installeren, kunt u dit beter door een daartoe gekwalificeerde technicus laten doen.

Note:

This unit is designed to operate on 12 V DC, **NEGATIVE ground electrical systems**. If your vehicle does not have this system, a voltage inverter is required, which can be purchased at JVC IN-CAR ENTERTAINMENT dealers.

- Replace the fuse with one of the specified rating. If the fuse blows frequently, consult your JVC IN-CAR ENTERTAINMENT dealer.
- If noise is a problem... This unit incorporates a noise filter in the power circuit. However, with some vehicles, clicking or other unwanted noise may occur. If this happens, connect the unit's rear ground terminal (see connection diagram) to the car's chassis using shorter and thicker cords, such as copper braiding or gauge wire. If noise still persists, consult your JVC IN-CAR ENTERTAINMENT dealer.
- Maximum input of the speakers should be no more than 40 W at the rear and 40 W at the front, with an impedance of 4 Ω to 8 Ω.
- **Be sure to ground this unit to the car's chassis.**
- The heat sink becomes very hot after use. Be careful not to touch it when removing this unit.

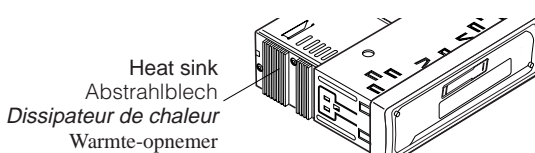

Hinweis:

Dieses Gerät ist für einen Betrieb in **elektrischen Anlagen mit 12 V Gleichstrom und (-) Erdung** ausgelegt. Verfügt Ihr Fahrzeug nicht über diese Anlage, ist ein Spannungsinverter erforderlich, der bei JVC Autoradiohändler erworben werden kann.

- Die Sicherung mit einer der entsprechenden Nennleistung ersetzen. Brennt die Sicherung häufig durch, wenden Sie sich an ihren JVC Autoradiohändler.
- Sind Störgeräusche ein Problem... Dieses Gerät enthält ein Störfilter im Stromkreis. Bei manchen Fahrzeugen kann jedoch ein Klicken oder andere unerwünschte Störgeräusche auftreten. Sollte das der Fall sein, die **hintere Erdungscanslußklemme** (siehe Schaltplan) des Geräts am Fahrwerk des Fahrzeugs anschließen, dabei kürzere und dickere Kabel wie beispielsweise Kupfergeflecht draht oder Stahldraht verwenden. Bleibt Störgeräusch bestehen, wenden Sie sich an Ihren JVC Autoradiohändler.
- Maximale Eingangsleistung der Lautsprecher sollte nicht mehr als 40 W hinten und 40 W vorne sein, mit einer Impedanz von 4 Ω bis 8 Ω.
- **Sicherstellen, daß das Gerät am Fahrwerk geerdet wird.**
- Das Abstrahlblech wird nach dem Gebrauch sehr heiß. Beim Ausbau des Geräts darauf achten, das Abstrahlblech nicht zu berühren.

Remarque:

Cet appareil est conçu pour fonctionner sur des sources de courant continu de 12 V à masse **NEGATIVE**. Si votre véhicule n'offre pas ce type d'alimentation, il vous faut un convertisseur de tension, que vous pouvez acheter chez un revendeur d'autoradios JVC.

- Remplacer le fusible par un de la valeur précisée. Si le fusible saute souvent, consulter votre revendeur d'autoradios JVC.
- Si le bruit est un problème... Cet appareil incorpore un filtre de bruit dans le circuit d'alimentation. Cependant, avec certains véhicules, quelques claquements ou autres bruits non désirés risquent de se produire. Si cela arrive, raccorder la borne arrière de masse de l'appareil au châssis de la voiture (voir le diagramme de raccordement) en utilisant des cordons les plus gros et les plus courts possibles telle qu'une barre de cuivre ou une tresse. Si le bruit persiste, consulter votre revendeur d'autoradios JVC.
- La puissance admissible des enceintes devrait n'être pas plus qu' c 40 W à l'arrière et à 40 W l'avant, avec une impédance de 4 Ω à 8 Ω.
- **S'assurer de raccorder la mise à la masse de cet appareil au châssis de la voiture.**
- Le dissipateur de chaleur devient très chaud après usage. Faire attention de ne pas le toucher en retirant cet appareil.

Opmerking:

Dit apparaat mag worden gebruikt bij elektrische systemen die werken op 12 V gelijkstroom met **negatieve aarding**. Als uw auto niet is uitgerust met een dergelijk systeem, is een spanningsomzetter vereist. Dit instrument kan worden aangeschaft bij JVC car audio dealers.

- Vervang de zekering door een exemplaar met het aangegeven vermogen. Als de zekering vaak doorslaat, moet u uw JVC car audio dealer raadplegen.
- Als u geluidsproblemen hebt... De krachtschakeling van dit apparaat heeft een ingebouwd geluidsfilter. In sommige voertuigen zijn tikgeluiden of andere ongewenste geluiden te horen. Als dit gebeurt, moet u de **massaklem aan de achterkant** (zie aansluitingsschema) aan het chassis van de auto vastmaken met behulp van een kortere en dikkere kabel, zoals kopermanteldraad of tellerkabel. Als het geluid niet verdwijnt, moet u contact opnemen met uw JVC car audio dealer.
- Het maximum ingangsvermogen van de speakers moet achterin niet meer dan 40 W zijn en voorin 40 W, met een impedantie van 4 Ω tot 8 Ω.
- **Zorg ervoor dat dit apparaat door middel van een aardkabel is verbonden met het chassis van de auto.**
- De warmte-opnemer kan na gebruik erg heet worden. Raak de warmte-opnemer niet aan wanneer u dit apparaat van zijn plaats haalt.

A If your car is equipped with the ISO connector
 Wenn Ihr Auto mit ISO-Steckern ausgestattet ist
 Si votre voiture est équipée d'un connecteur ISO
 Indien uw auto is uitgerust met de ISO-connector

- Connect the ISO connectors as illustrated.
- Die ISO-Stecker wie abgebildet anschließen.
- Connectez les connecteurs ISO comme montré sur l'illustration.
- Sluit de ISO-connectoren aan zoals op het voorbeeld is aangegeven.

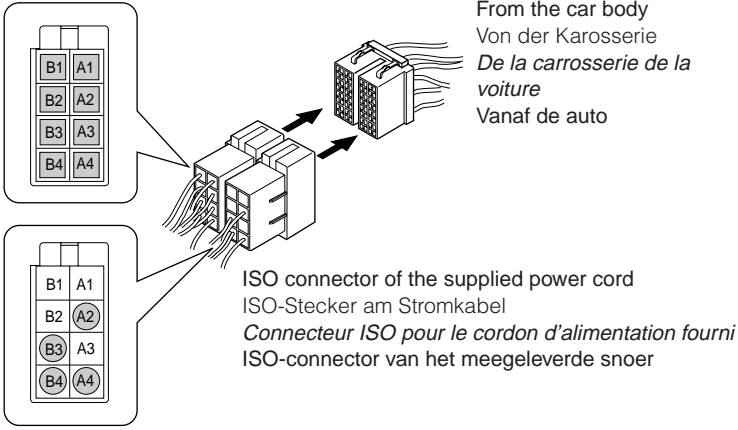

View from the lead side
 Ansicht von der Leitungsseite
 Vue à partir du côté des fils
 Aanzicht vanaf het snoer

For some VW/Audi or Opel (Vauxhall) automobile
Für manche VW/Audi oder Opel (Vauxhall) Fahrzeuge
Pour certaine voiture VW/Audi ou Opel (Vauxhall)
Voor bepaalde modellen VW/Audi of Opel (Vauxhall) geldt

You may need to modify the wiring of the supplied power cord as illustrated.
 Sie müssen evtl. die Verdrahtung des mitgelieferten Stromkabels wie abgebildet ändern.
 Vous aurez peut-être besoin de modifier le câblage du cordon d'alimentation fourni comme montré sur l'illustration.
 Wellicht moet u de bedrading van het meegeleverde snoer als in het voorbeeld aanpassen.

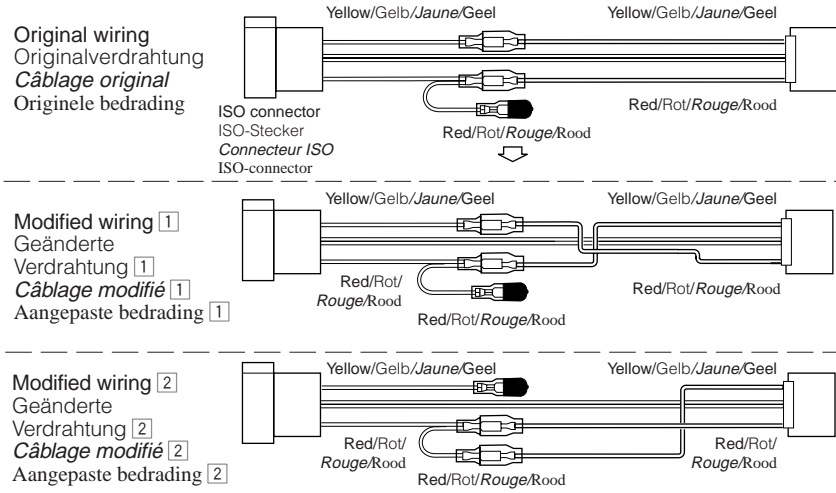

Use modified wiring [2] if the unit does not turn on.
 Geänderte Verdrahtung [2] verwenden, wenn das Gerät so nicht an geht.
 Utilisez le câblage modifié [2] si l'appareil ne se met pas sous tension.
 Pas de bedrading [2] aan indien het apparaat niet reageert bij inschakelen.

B Connections without using the ISO connectors / Anschlüsse ohne ISO-Stecker / Connexions sans l'utilisation des connecteurs ISO /
 Verbindungen zonder ISO-connectoren

Before connecting: Check the wiring in the vehicle carefully. Incorrect connection may cause serious damage to this unit.

Vor dem Anschließen: Die Verdrahtung im Fahrzeug sorgfältig überprüfen. Falsche Anschlüsse können ernsthafte Schäden am Gerät hervorrufen.

Avant de commencer la connexion: Vérifiez attentivement le câblage du véhicule. Une connexion incorrecte peut endommager sérieusement l'appareil.

Alvorens de verbindingen tot stand te brengen: Moet u de bedrading in de auto zorgvuldig. Het apparaat kan door verkeerde verbindingen ernstige schade oplopen.

- 1 Cut the ISO connector.
- 2 Connect the colored leads of the power cord to the car battery, speakers and power aerial (if any) in the following sequence.
 - 1 Black: ground
 - 2 Yellow: to car battery (constant 12 V)
 - 3 Red: to an accessory terminal
 - 4 Blue with white stripe: to power aerial (200 mA max.)
 - 5 Others: to speakers
- 3 Connect the aerial cord.
- 4 Finally connect the wiring harness to the unit.

- 1 Den ISO-Stecker abschneiden.
- 2 Die farbigen Leitungen des Spannungsversorgungskabels an der Autobatterie, ontstekingsschakelaarden Lautsprechern und dem Motorantenne (sofern vorhanden) in folgender Reihenfolge anschließen.
 - 1 Schwarz: Erdung
 - 2 Gelb: an Autobatterie (konstant 12 V)
 - 3 Rot: zur einer Zubehöransteckleiste
 - 4 Blau mit weißem Streifen: zur Motorantenne (max. 200 mA)
 - 5 Andere: zur Lautsprecher
- 3 Das Antennenkabel anschließen.
- 4 Die Kabelbäume am Gerät anschließen.

- 1 Coupez le connecteur ISO.
- 2 Connectez les fils de couleur du cordon d'alimentation à la batterie de la voiture, aux enceintes et à l'antenne automatique (s'il y en a une) dans l'ordre suivant.
 - 1 Noir: à la masse
 - 2 Jaune: à la batterie de la voiture (12 V constant)
 - 3 Rouge: à une borne accessoire
 - 4 Bleu avec bande blanche: à l'antenne automatique (200 mA max.)
 - 5 Autres: aux enceintes
- 3 Connectez le cordon d'antenne.
- 4 Finalement, connectez le faisceau de fils à l'appareil.

- 1 Knip de ISO-connector los.
- 2 Sluit de gekleurde snoerdraden van de stroomkabel in de hierna genoemde volgorde aan op de accu van de auto, de luidsprekers en de antenne (indien aanwezig).
 - 1 Zwart: aarde
 - 2 Geel: naar de accu van de auto (constant 12 V)
 - 3 Rood: naar de aansluitklem van de accessoire
 - 4 Blauw met witte streep: naar de antenne (Max. 200 mA)
 - 5 Andere: naar de speakers
- 3 Sluit de antenne aan.
- 4 Verbind de draadbundel daarna met het apparaat.

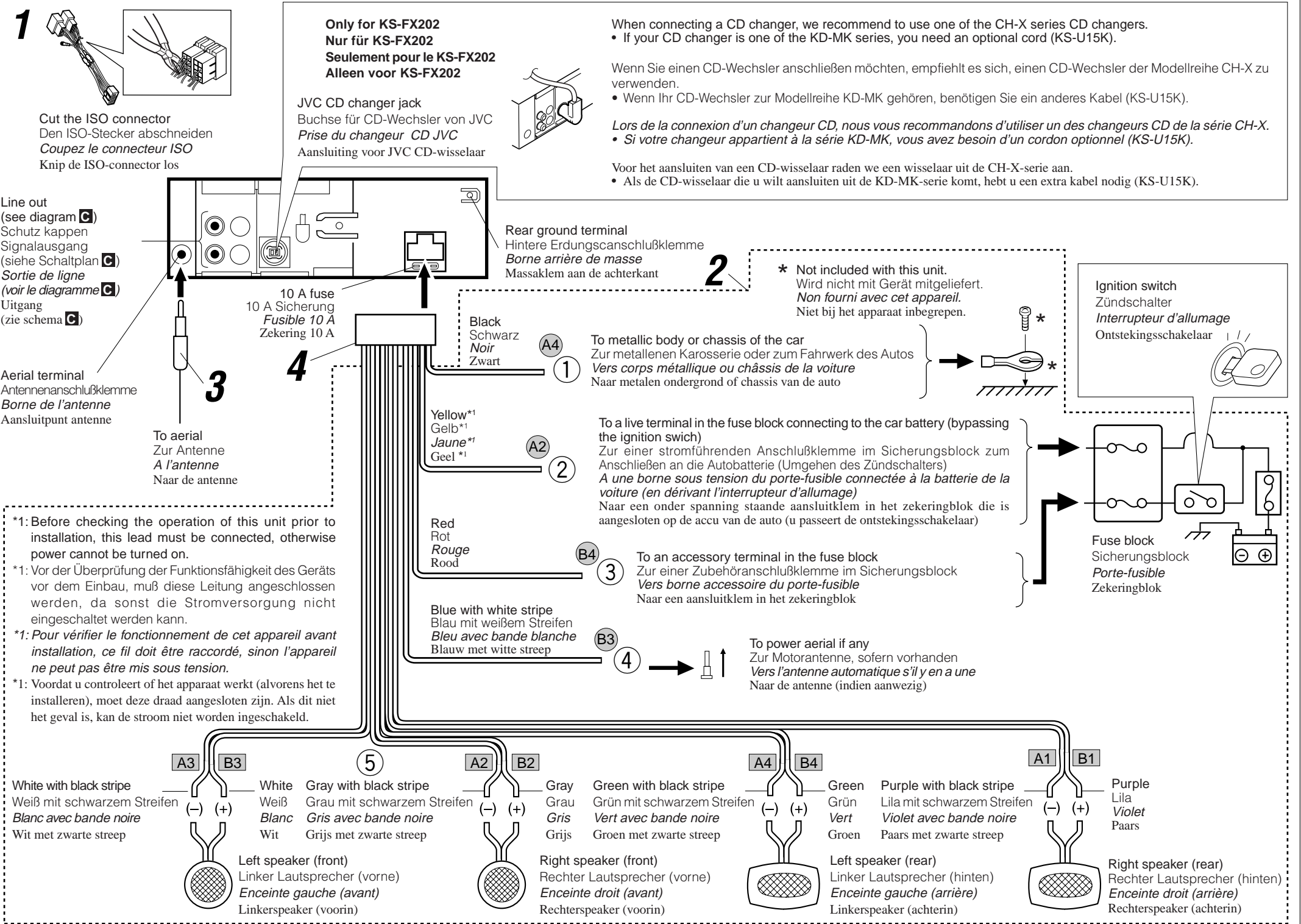

PRECAUTIONS on power supply and speaker connections:

- DO NOT connect the speaker leads of the power cord to the car battery; otherwise, the unit will be seriously damaged.
- Connect the black lead (ground), yellow lead (to car battery, constant 12 V), and red lead (to an accessory terminal) correctly.
- BEFORE connecting the speaker leads of the power cord to the speakers, check the speaker wiring in your car.
 - If the speaker wiring in your car is as illustrated in Fig. 1 and Fig. 2 below, DO NOT connect the unit using that original speaker wiring. If you do, the unit will be seriously damaged.
 - Redo the speaker wiring so that you can connect the unit to the speakers as illustrated in Fig. 3.
 - If the speaker wiring in your car is as illustrated in Fig. 3, you can connect the unit using the original speaker wiring in your car.
 - If you are not sure of the speaker wiring of your car, consult your car dealer.

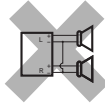

Fig. 1

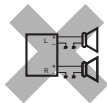

Fig. 2

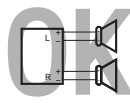

Fig. 3

VORSICHTSMASSREGELN beim Anschließen der Stromversorgung und Lautsprecher:

- Die Lautsprecherleitungen des Netzkabels NICHT an der Autobatterie anschließen, da sonst das Gerät schwer beschädigt wird.
- Die schwarze Leitung (Erdung), die gelbe Leitung (zur Autobatterie, konstant 12 V) und die rote Leitung (zur Zuhörerschlußklemme) richtig anschließen.
- VOR dem Anschließen der Lautsprecherleitungen des Spannungsversorgungskabels an die Lautsprecher, die Lautsprecherverdrahtung in Ihrem Auto überprüfen.
 - Ist die Lautsprecherverdrahtung wie unten in „Fig. 1“ und „Fig. 2“ abgebildet, das Gerät NICHT mit der Originalverdrahtung der Lautsprecher anschließen, da sonst das Gerät schwer beschädigt wird.
 - Die Lautsprecherverdrahtung erneuern, so daß Sie das Gerät an den Lautsprechern wie in „Fig. 3“ abgebildet anschließen können.
 - Ist die Lautsprecherverdrahtung in Ihrem Auto wie in „Fig. 3“ abgebildet, können Sie das Gerät mit der Originalverdrahtung der Lautsprecher in Ihrem Auto anschließen.
 - Sind Sie sich über die Lautsprecherverdrahtung in Ihrem Auto nicht sicher, wenden Sie sich an Ihren Autohändler.

PRECAUTIONS sur l'alimentation et la connexion des enceintes:

- NE CONNECTEZ PAS les fils d'enceintes du cordon d'alimentation à la batterie; sinon, l'appareil serait sérieusement endommagé.
- Connectez correctement le fil noir (à la masse), le fil jaune (à la batterie de la voiture, 12 V constant) et le fil rouge (à la prise accessoire).
- AVANT de connecter les fils d'enceintes du cordon d'alimentation aux enceintes, vérifiez le câblage des enceintes de votre voiture.
 - Si le câblage des enceintes de votre voiture est comme montré sur la Fig. 1 ou Fig. 2 ci-dessous, NE CONNECTEZ PAS l'appareil en utilisant ce câblage original des enceintes. Si vous le faites, l'appareil sera sérieusement endommagé.
 - Recommencez le câblage des enceintes de façon que vous puissiez connecter l'appareil aux enceintes comme montré sur la Fig. 3.
 - Si le câblage des enceintes de votre voiture est comme montré sur la Fig. 3, vous pouvez connecter l'appareil en utilisant ce câblage original d'enceintes pour votre voiture.
 - Si vous n'êtes pas sûrs du câblage d'enceintes de votre voiture, consulter le concessionnaire de votre voiture.

VOORZORGSMAATREGELEN bij het verbinden van de stroomkabeldraad met de speakers:

- Verbind de speakerdraden van de stroomkabel NIET met de accu van de auto; als u dit wel doet, zal het apparaat ernstige schade oplopen.
- Sluit de zwarte draad (aarde), de gele draad (naar de auto, constant 12 V) en de rode draad (naar de aansluitklem van de accessoire) op de juiste wijze aan.
- VOORDAT u de speakerdraden van de stroomkabel met de speakers verbindt, moet u de bedrading van de speakers in uw auto controleren.
 - Als de bedrading van de speakers eruitziet zoals hieronder staat afgebeeld in Fig. 1 en Fig. 2, mag het apparaat NIET worden aangesloten met behulp van deze oorspronkelijke speakerbedrading. Als u dat wel doet, zal het apparaat ernstige schade oplopen.
 - Pas de bedrading van de speakers aan, zodat u het apparaat met de speakers kunt verbinden, zoals staat afgebeeld in Fig. 3.
 - Als de bedrading van de speakers eruitziet zoals staat afgebeeld in Fig. 3, kunt u het apparaat aansluiten met behulp van de oorspronkelijke speakerbedrading in uw auto.
 - Als u twijfels hebt over de speakerbedrading in uw auto, moet u contact opnemen met uw autodealer.

Connecting the leads / Anschließen der Leitungen / Raccordement des fils / Aansluiting van de gekleurde draden

Twist the core wires when connecting. Die Kerndrähte beim Anschließen verdrehen. Torsader les âmes des fils en les raccordant. Draai de kerndraden om elkaar heen wanneer u ze wilt aansluiten.

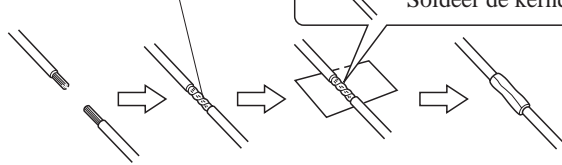

Solder the core wires to connect them securely. Die Kerndrähte anlöten, um sie fest anzuschließen. Souder les âmes des fils pour les raccorder entre eux de façon sûre. Soldeer de kerndraden zodat ze stevig vast zitten.

CAUTION / VORSICHT / PRECAUTION / LET OPI:

- To prevent short-circuit, cover the terminals of the UNUSED leads with insulating tape.
- Zur Vermeidung eines Kurzschlusses die Anschlußklemmen der NICHT VERWENDETEN Leitungen mit Isolierklebeband umwickeln.
- Pour éviter les court-circuits, couvrir les bornes des fils qui ne sont PAS utilisés avec de la bande isolante.
- Om kortsluiting te voorkomen, moet u de aansluitklemmen van ONGEBRUIKTE gekleurde draden met isolatieband bedekken.

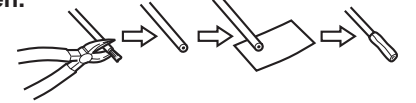

Connections Adding Other Equipment / Anschlüsse zum Hinzufügen von anderer Ausrüstung / Raccordement pour ajouter d'autres appareils / Aansluitingen voor het toevoegen van andere apparatuur

Amplifier / Verstärker / Amplificateur / Versterker

You can connect an amplifier and other equipment to upgrade your car stereo system.

- Connect the remote lead (blue with white stripe) to the remote lead of the other equipment so that it can be controlled through this unit.
- For amplifier only:
 - Connect this unit's line-out terminals to the amplifier's line-in terminals.
 - Disconnect the speakers from this unit, connect them to the amplifier. Leave the speaker leads of this unit unused. (Cover the terminals of these unused leads with insulating tape, as illustrated above.)

Sie können einen Verstärker oder ein anderes Gerät anschließen, um Ihre Autostereoanlage zu erweitern.

- Schließen Sie das Fernbedienungskabel (blau mit weißem Streifen) an das Fernbedienungskabel des anderen Geräts an, so daß es über dieses Gerät gesteuert werden kann.
- Nur für den Verstärker:
 - Die Anschlußklemmen am Ausgang dieses Gerät an den Anschlußklemmen des Eingangs des Verstärkers anschließen.
 - Die Lautsprecher von diesem Gerät abtrennen und am Verstärker anschließen. Die Lautsprecherleitungen dieses Geräts unbenutzt lassen. (Die Anschlußklemmen dieser nicht verwendeten Leitungen mit Isolierklebeband umwickeln, siehe Abbildung oben.)

Vous pouvez connecter un amplificateur ou autre appareil pour améliorer votre système autoradio.

- Connectez le fil de commande à distance (bleu avec bande blanche) au fil de commande à distance de l'autre appareil de façon qu'il puisse être commandé via cet appareil.
- Pour l'amplificateur seulement:
 - Raccorder les bornes de sortie ligne de cet appareil aux bornes d'entrée ligne de l'amplificateur.
 - Déconnectez les enceintes de cet appareil et connectez-les à l'amplificateur. Laissez les fils d'enceintes de cet appareil inutilisés. (Recouvrir les extrémités de ces fils inutilisés avec de la bande isolante comme montré ci-dessus.)

Het is mogelijk om uw autostereosysteem uit te breiden met een versterker of andere apparatuur.

- Verbind de externe kabel (blauw met witte streep) met de externe kabel van het andere apparaat zodat deze op afstand vanaf deze apparaat kan worden bediend.
- Alleen voor een versterker:
 - Verbind de uitgang van het apparaat met de ingang van de versterker.
 - Koppel de speakers van dit apparaat los en verbind ze aan de versterker. Gebruik de speakerdraden van dit apparaat niet. (Plak de aansluitklemmen van deze speakerdraden met isolatieband af zoals hierboven is afgebeeld.)

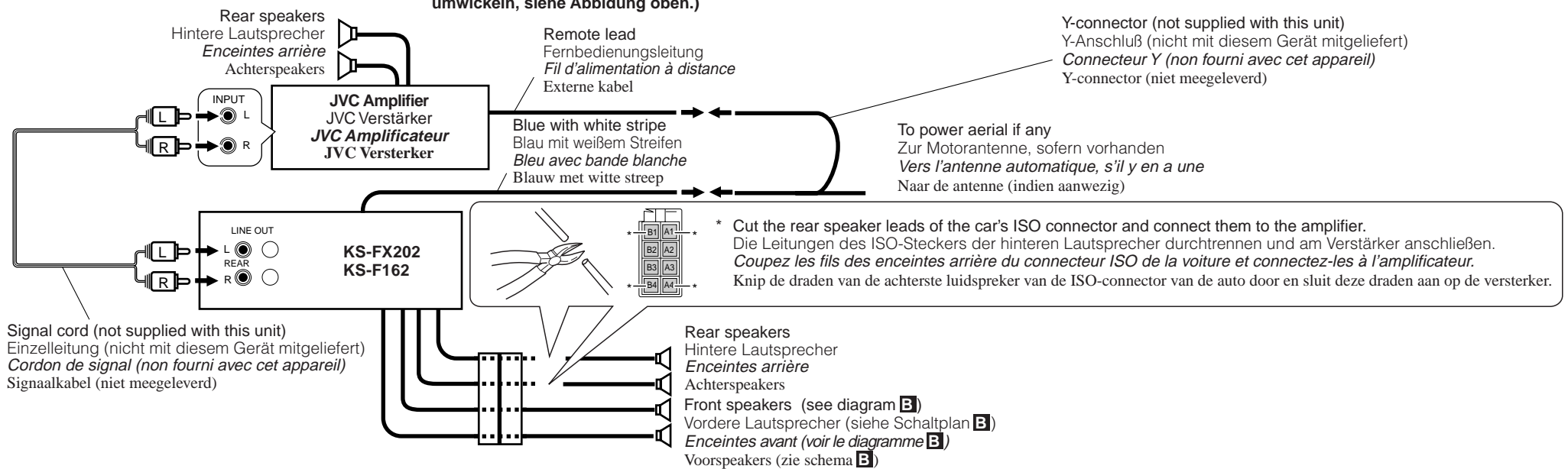

CD changer / CD-Wechsler / Changeur CD / CD-wisselaar

Only for KS-FX202:

You can connect a JVC CD changer.

- For the connections, refer to the instructions supplied with them.

Nur für KS-FX202:

Sie können einen CD-Wechsler von JVC.

- Weitere Informationen über den Anschluß können Sie der Bedienungsanleitung entnehmen, die dem jeweiligen Gerät beiliegt.

Seulement pour le KS-FX202:

Vous pouvez connecter un changeur CD JVC.

- Pour les connexions, référez-vous aux modes d'emploi qui les accompagnent.

Alleen voor KS-FX202:

Het is mogelijk een JVC CD-wisselaar aan te sluiten.

- Zie de instructies van deze apparaten voor meer informatie over het tot stand brengen van deze aansluiting.

Connecting cord supplied with your CD changer. Verbindungskabel, das zum Lieferumfang des CD-Wechsler gehört. Cordon de connexion fourni avec votre changeur CD. Verbindungskabel die met de CD-wisselaar wordt meegeleverd.

KS-FX202

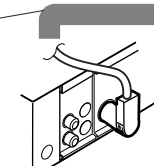

JVC CD changer
CD-Wechsler von JVC
Changeur CD JVC
JVC CD-wisselaar

CAUTION / VORSICHT / PRECAUTION / LET OPI:

- Before connecting the CD changer, make sure that the unit is turned off.
- Bevor Sie den CD-Wechsler anschließen, vergewissern Sie sich, daß das Gerät ausgeschaltet ist.
- Avant de connecter le changeur CD, s'assurer que l'unité est éteinte.
- Zorg ervoor dat de apparat is uitgeschakeld alvorens u de CD-wisselaar aansluit.

TROUBLESHOOTING

FEHLERSUCHE

EN CAS DE DIFFICULTES

PROBLEMEN OPLOSSEN

- The fuse blows.
 - * Are the red and black leads connected correctly?
- Power cannot be turned on.
 - * Is the yellow lead connected?
- No sound from the speakers.
 - * Is the speaker output lead short-circuited?
- Sound is distorted.
 - * Is the speaker output lead grounded?
 - * Are the “-” terminals of L and R speakers grounded in common?
- Unit becomes hot.
 - * Is the speaker output lead grounded?
 - * Are the “-” terminals of L and R speakers grounded in common?

- Die Sicherung brennt durch.
 - * Sind die roten und schwarzen Leitungen richtig angeschlossen?
- Stromversorgung kann nicht eingeschaltet werden.
 - * Ist die gelbe Leitung angeschlossen?
- Kein Ton aus den Lautsprechern.
 - * Ist die Lautsprecherausgangsleitung kurzgeschlossen?
- Ton verzerrt.
 - * Ist die Lautsprecherausgangsleitung geerdet?
 - * Sind die (-) Anschlußklemmen der linken und rechten Lautsprecher zusammen geerdet?
- Gerät wird heiß.
 - * Ist die Lautsprecherausgangsleitung geerdet?
 - * Sind die (-) Anschlußklemmen der linken und rechten Lautsprecher zusammen geerdet?

- Le fusible saute.
 - * Les fils rouge et noir sont-ils raccordés correctement?
- L'appareil ne peut pas être mise sous tension.
 - * Le fil jaune est-elle raccordée?
- Pas de son des enceintes.
 - * Le fil de sortie d'enceinte est-il court-circuité?
- Le son est déformé.
 - * Le fil de sortie d'enceinte est-il à la masse?
 - * Les bornes “-” des enceintes gauche et droit sont-elles mises ensemble à la masse?
- L'appareil devient chaud.
 - * Le fil de sortie d'enceinte est-il à la masse?
 - * Les bornes “-” des enceintes gauche et droit sont-elles mises ensemble à la masse?

- De zekering slaat door.
 - * Zijn de rode en de zwarte draden op de juiste manier aangesloten?
- De stroom kan niet worden ingeschakeld.
 - * Is de gele draad aangesloten?
- Er komt geen geluid uit de speakers.
 - * Is de uitgaande speakerdraad kortgesloten?
- Het geluid wordt vervormd.
 - * Is de uitgaande speakerdraad geaard?
 - * Zijn de minpolen van de linker- en de rechterspeakers gemeenschappelijk geaard?
- Het apparaat raakt verhit.
 - * Is de uitgaande speakerdraad geaard?
 - * Zijn de minpolen van de linker- en de rechterspeakers gemeenschappelijk geaard?